

MODEL "K" DIFFUSER WITH ADJUSTABLE BLADE 3-Slot Model

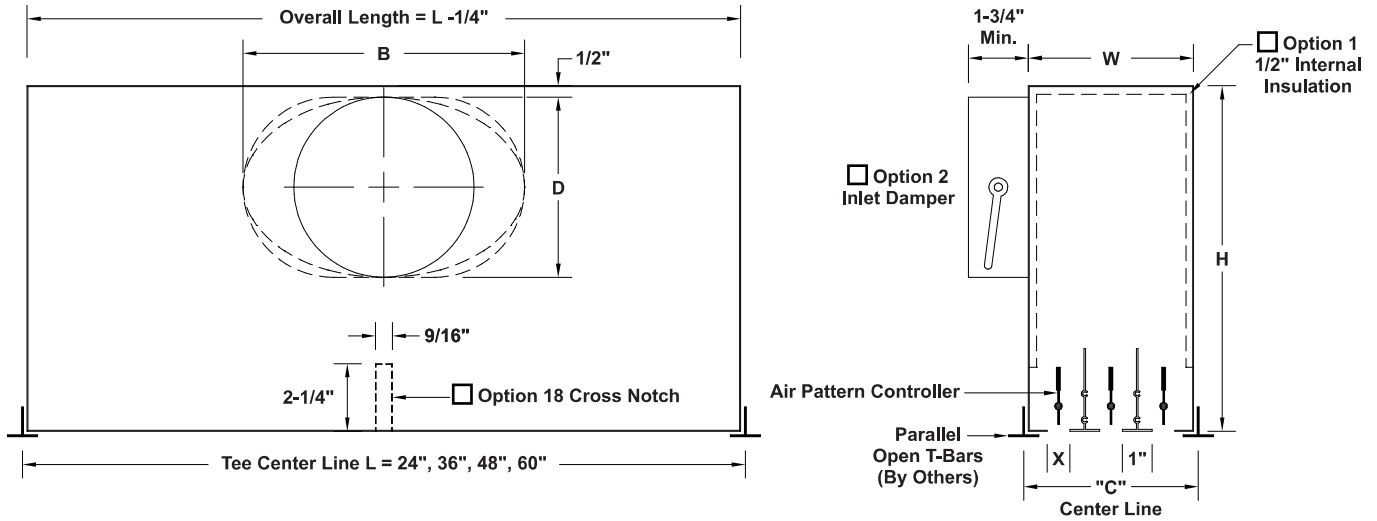

ACCESSORY OPTIONS

NOMINAL INLET SIZE	B	D	H
6" RD.	5-7/8"	5-7/8"	11-5/8"
8" RD.	7-7/8"	7-7/8"	
10" OV.	11-1/2"	8"	
12" SLOT	14-1/2"	8"	
10" RD.	9-7/8"	9-7/8"	13-5/8"
12" OV.	13-7/8"	9-9/16"	
12" RD.	11-7/8"	11-7/8"	

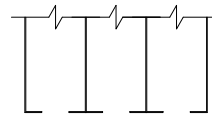

Standard
Two Center T's
No side T's or
clips furnished

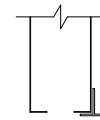

Option 5
One side T
furnished *

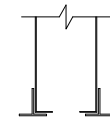

Option 7
Both side T's
furnished

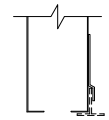

Option 8
One pair of
TC clips
furnished *

MODEL	SLOT WIDTH X	W	C
K-50-3	1/2"	4-5/8"	4-7/8"
K-75-3	3/4"	5-3/8"	5-5/8"
K-100-3	1"	6-1/8"	6-3/8"
K-150-3	1-1/2"	7-5/8"	7-7/8"

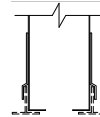

Option 9
Both pairs of
TC clips
furnished

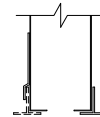

Option 10
One pair of
TC clips and one
side T furnished *

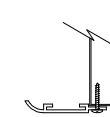

Option 11
Frame
screwed onto
plenum lip using
pan head screws.
Off-white finish.
Shipped loose.

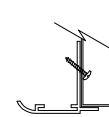

Option 12
Frame for concealed
fastening.
Off-white finish.
Shipped loose.
Field Drilled.

Material: 24 gauge zinc coated steel. Pattern controller extruded aluminum with felt wiper seal.

Finish: Diffuser face and pattern controller flat black, tees are white.

Inlet Collar Location: Inlet collar may be offset for packaging purposes.

* Specify inlet side or side opposite inlet if ordering Options 5, 8, or 10.

Quantity	Model	Length L	Height H	Inlet Size	Options	Tag

To maintain KEES' policy of continuous product development, we reserve the right to change prices, specifications, ratings and dimensions without notice or obligation.

Project	Location
Engineer	Dwg. No. Diff. KS-3
Architect	Date 05/10
Contractor	



KEES INCORPORATED
400 S. Industrial Dr.
Elkhart Lake, WI 53020
Phone: (920) 876-3391
Fax: (920) 876-3065
Website: www.kees.com